

Lupo
Made in Italy

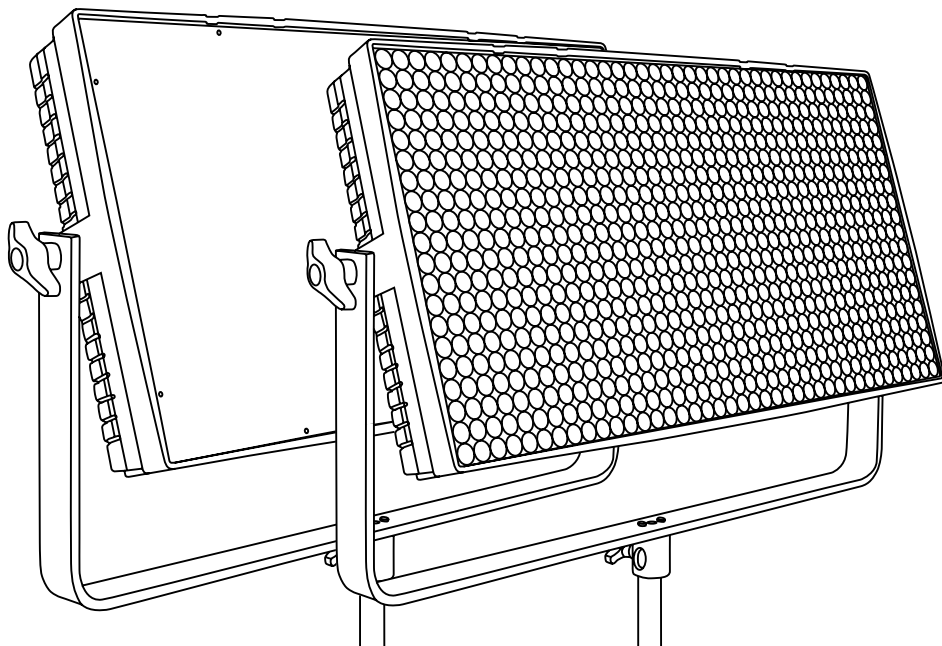

User Manual

Superpanel FULL COLOR 60 Hard / Soft

Release 4.xx

SAFETY PRECAUTIONS:

Do not operate the equipment before studying the instruction manual and the accompanying safety precautions. Make sure that Lupo Safety Instruction is always included with the equipment! Lupo products are intended for professional use. Do not place or use the equipment where it can be exposed to moisture, extreme electromagnetic fields or in areas with flammable gases or dust! Do not expose the equipment to hasty temperature changes in humid condition as could lead to condensation water in the unit. Equipment must only be serviced, modified or repaired by authorized. Dealers or the factory.

CAUTION - BURN HAZARD - HOT PARTS

Do not touch hot parts with bare fingers! LED bulbs and certain metal parts emit strong heat when used!
Do not point lamps too close to persons.
Always use the fixtures with the front part closed.

NOTICE - EQUIPMENT OVERHEATING RISK

Do not obstruct ventilation by placing filters, diffusing materials, etc. over inlets and outlets of the equipment ventilation or directly over glass cover or LED bulbs.

FINAL DISPOSAL

Equipment contains electrical and electronic components that could be harmful to the environment.
Equipment may be returned to Lupo distributors free of charge for recycling according to WEEE.

Follow local legal requirements for separate disposal of waste, for instance WEEE directive for electrical and electronic equipment on the European market, when product life has ended.

MAINTENANCE AND CARE

Please do not forget that the safe operation of lampheads also includes their maintenance and care.

A visual inspection should be conducted before every use and an inspection of electrical safety should be conducted at least once every 12 months.

WARRANTY

The warranty period for Lupo products and those marketed by Lupo is twelve months from the date of delivery. Lupo guarantees that the goods it supplies are well manufactured and of good quality. The warranty guarantees the repair of any parts that show acknowledged defects in materials, construction or workmanship during the warranty period. The guarantee excludes any liability for direct or indirect damage of any kind and for any reason, for which Lupo will therefore not be required to pay compensation. The customers shall see to deliver the parts that need repair or replacement to Lupo's works at their own expense and risk. The repaired or replacement parts shall be delivered by Lupo ex-works. The customers will be charged for materials and labor or replacement of the product after the expiration of the warranty period.

⚠ WARNING:

When hanging the fixture from higher position, please make sure you use safety cable to attach the barndoors to the yoke of the panel.

Barndoors should always be used to secure the fixture and the application when used in this way.

Another safety cable should be used to secure the fixture to the mounting pipe or truss.

Both safety cables must be properly dimensioned for the fixture and the application when the fixture is operated in hanging position please ensure that the accessories are installed correctly with top latch locked.

*Thanks for having purchased **Lupo** products. All the products are made in Italy and all the efforts have been put to keep the quality standards high. We hope this product can help you in your job and make your life easier as a professional. We also hope you will enjoy its use and we would be happy to receive your feedback about it.*

Instructions

- Device for indoor use only.
- Maximum ambient temperature: 40 °C.
- Make sure power supply plug is suitable to power required.
- As prescribed by international regulations, a safety cable must be used when the fixture is suspended from ceiling.
- To switch on the light push the on/off button.
- Superpanel models are equipped with new generation high quality poweredleds.

Getting Started

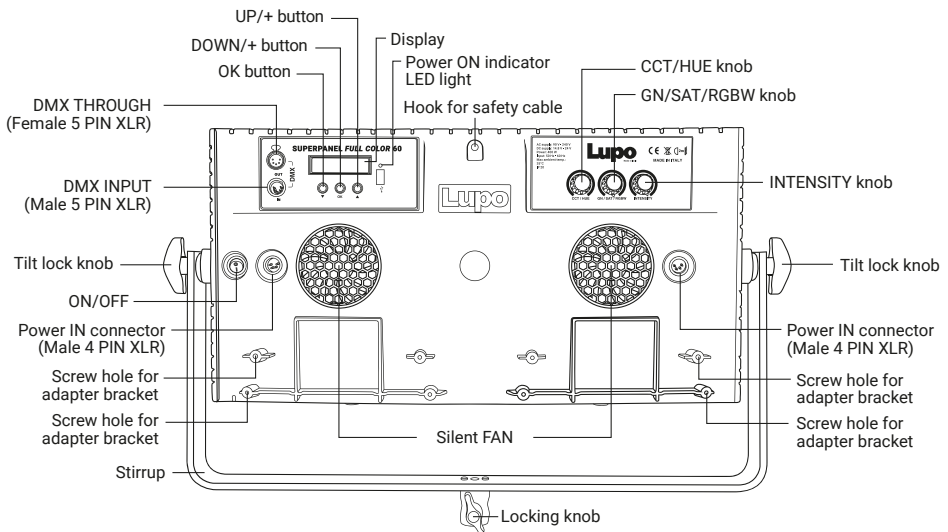

Turning on the Superpanel

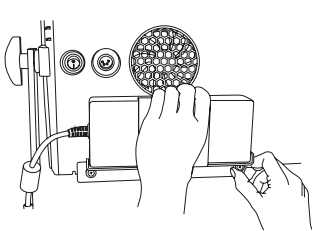

- 1** Place the AC Adapters in the mounting brackets via the 2 captive screws to the bottom of the SUPERPANEL FULL COLOR 60 fixture.

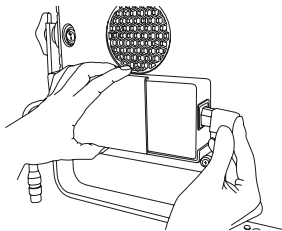

- 2** Insert the power cord cables into the AC adapters and connect the power plug.

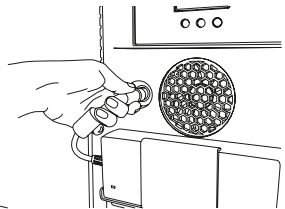

- 3** Insert the DC XLR 4 pin connectors into the input jacks on the SUPERPANEL FULL COLOR 60 and **power on** the fixture.

Functioning

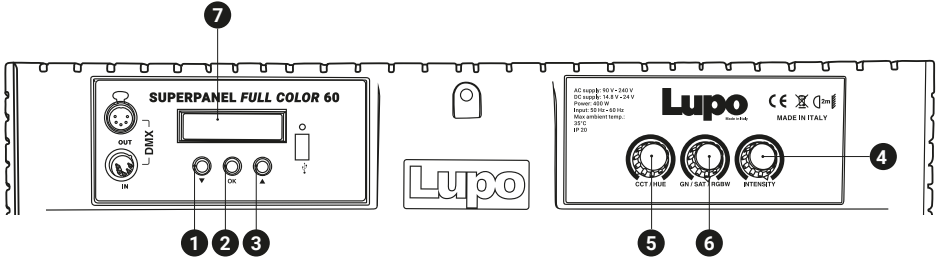

CONTROL PANEL

- In current mode press the « **OK** » **2** button to enter the main MENU.
- In the sub-menus press the « **OK** » **2** button to confirm a selection.
- Use the « **▼** » **1** or « **▲** » **3** buttons to navigate in the main MENU and sub-menus.
- Use the « **INTENSITY** » **4** knob to adjust the **light intensity from 0 to 100%**.
- Use the knobs **5** and **6** to adjust the light mode parameters.
- Display **7**.

⚠ ATTENTION: The **light intensity** level will be adjustable from **0 - 50%** if the **FAN** is **OFF**.
The value on the display flashes.

MANUAL OPERATION

1. Press the « **OK** » **2** button to enter the main MENU.
2. Select **MANUAL** by pressing the « **OK** » **2** button.
3. Select the light mode between **CCT / HSI / RGBW / PRESET / EFFECT** with the « **▼** » **1** or « **▲** » **3** button, press « **OK** » **2** to confirm selection.
4. See **LIGHT MODES**.

DMX OPERATION

1. Press the « **OK** » **2** button to enter the main MENU.
2. Select **DMX** with the « **▲** » **3** button, press « **OK** » **2** button to confirm selection.
3. Select the light mode between **CCT / HSI / RGBW / FRGBW / PRESET / EFFECT** with the « **▼** » **1** or « **▲** » **3** button, press « **OK** » **2** to confirm selection.
5. Select the DMX channel, use the « **▼** » **1** and « **▲** » **3** buttons to change DMX ADDRESS in ascending or descending order between 1 and 512. The number shown on the display **7** is the selected channel to communicate with the control desk.
6. See **DMX PROTOCOL MANUAL** to DMX channel specification.

NOTE: The symbol - ! - on the display indicates that there is **no DMX signal**.

USB port

Use USB port for firmware updates.

DMX OPERATION - Advanced Settings

1. Press the « OK » ② button to enter the main MENU.
2. Navigate through the main MENU with the « ▼ » ① or « ▲ » ③ buttons to the **DMX** item, select by pressing the « OK » ② button.
3. Press the « ▼ » ① or « ▲ » ③ buttons to select **DMX ADVANCED**, press « OK » ② button to confirm selection.
4. Select one of the options between the **DMX BIT** and **DMX SIGNAL LOSS**, press « OK » ② to confirm the selection.

DMX BIT:

Resolution of the DMX control. 8bit 1 channel per function and 16 bit 2 channels per function.

1. Select the **DMX BIT** item by pressing the « OK » ② button.
2. Use the « ▼ » ① or « ▲ » ③ buttons to choose between **8bit / 16bit**, press the « OK » ② button to confirm the selected setting. See **DMX PROTOCOL MANUAL**.

DMX SIGNAL LOSS:

This feature allows to choose the device's behaviour in case of a DMX signal loss.

1. Select the **LOSS DMX SIGNAL** item with the « OK » ② button.
2. Use the « ▼ » ① or « ▲ » ③ buttons to select the device's behaviour between **BLACK OUT / SETTINGS LAST / SETTINGS 1min**, press the « OK » ② button to confirm the setting.

Black out: The device switches off.

Settings Last: The values of the last selected setting are maintained over time until the device is switched off.

Settings 1min: The values of the last selected settings will be maintained for one minute and then the device will switch off.

LIGHT MODES

MODE	INTENSITY ④	CCT/HUE ⑤	GN/SAT/COLOR ⑥	« ▼ » ① « ▲ » ③
CCT	Light Intensity from 0 to 100%	CT 2800K to 10000K	GN -1.00 to +1.00	-
HSI		HUE 0° to 100°	SAT 0 to 100%	-
RGBW		-	Select function R/G/B/W/CT/GN	Change values of the function
PRESET		-	-	Change Preset
EFFECT		"See EFFECT table"	"See EFFECT table"	Change Effect

A. CCT MODE: Warm and cold white control mode. It allows you to adjust colour temperature (CCT), green/magenta compensation (GN) and light intensity. *This is the default setting.*

B. HSI MODE: Colour composition mode. It allows you to adjust hue of colour (HUE), colour saturation (SAT) and light intensity.

C. RGBW MODE: RGBW colour control mode allows to individually set the R, G, B, W, Color Temperature (CT), green/magenta compensation (GN) values and to adjust light intensity

D. FRGBW MODE: Available only in DMX operation. Same as RGBW but with white color power unlimited. See **DMX PROTOCOL MANUAL**.

E. PRESET MODE: Mode with 53 PRESET colors, 48 factory preset and 5 user-defined preset.

1. In MANUAL OPTIONS or DMX MODE menu select **PRESET MODE**.
2. Select the PRESET to be activated with the « ▼ » ❶ or « ▲ » ❸ buttons, confirm the selection by pressing the « OK » ❷ button.
3. In current mode, use the « ▼ » ❶ or « ▲ » ❸ button to change the PRESET in ascending or descending order. **THE PRESET ON THE DISPLAY IS THE SELECTED PRESET.**
4. Use the « INTENSITY » ❹ knob to adjust the **light intensity from 0 to 100%**.

SAVING THE SET VALUES AS A PRESET

You can store up to **5 PRESETS**.

1. In CCT / HSI / RGBW mode, press the « ▼ » ❶ and « ▲ » ❸ at the same time.
2. Save the set values in one of the available presets between **USER PRESET 1 / 2 / 3 / 4 / 5** press the « ▼ » ❶ or « ▲ » ❸ button to select the PRESET number and press « OK » ❷ to confirm the selection. **THE SET COLOR IS SAVED AS PRESET.**

"**BUSY**" indicates that in the user preset there are parameters memorized if you select it, the parameters will be replaced by the new ones. "**EMPTY**" indicates that the user preset is free.

E. SPECIAL EFFECT MODE: Mode with 10 SPECIAL EFFECTS. **STROBE / PARTY / COPCAR / DISCO / TELEVISION / PAPARAZZI / LIGHTNING / EXPLOSION / FIREWORKS / FIRE.**

1. In MANUAL OPTIONS or DMX MODE menu select **EFFECT MODE**.
2. Select the EFFECT to be activated with the « ▼ » ❶ or « ▲ » ❸ buttons, confirm the selection by pressing the « OK » ❷ button.
3. In current mode, use the « ▼ » ❶ or « ▲ » ❸ button to change the EFFECT in ascending or descending order. **THE EFFECT ON THE DISPLAY IS THE SELECTED EFFECT.**
4. Use the knobs ❺ and ❻ to adjust the effect setting values. **See table below.**

⚠ ATTENTION - Only to STROBE effect

1. The strobe effect is **AVAILABLE ONLY IN MANUAL OPERATION**.
2. The strobe effect is applied to the parameters of the last configured CCT/HSI/RGBW/ PRESET mode.
3. The STROBE effect is **NOT WORK** if PARTY, COPCAR, DISCO, TELEVISION, PAPARAZZI, LIGHTNING, EXPLOSION, FIREWORKS or FIRE effects are in functioning.

EFFECT	❹ INTENSITY knob	❺ CCT/HUE knob	❻ GN/SAT/COLOR knob
STROBE	Light Intensity from 0 to 100%	Frequency - 1 to 25 Hz	-
PARTY		Speed - 0 to 100%	-
COPCAR		Flash Color - B / R / R+B / B+W / R+B+W	Nº flashes for cycle - 1 to 4
DISCO		Speed - 0 to 100%	-
TELEVISION		White range - 1 / 2 / 3 / 4	Frequency - 4 to 24 Hz
PAPARAZZI		Flashing Interval - 1 to 10	Bulb type - 0 / 1 / 2
LIGHTNING		Color Temperature	Lightnings Interval - 1 to 20
EXPLOSION		Speed - 1 to 60	-
FIREWORKS		Speed - 1 to 60	-
FIRE		Speed - 1 to 3	-

DEVICE SETTINGS

1. Press the « OK » ② button to enter the main MENU.
2. Navigate through the MENU using the « ▼ » ① or « ▲ » ③ buttons, select **DEVICE SETTINGS**, press the « OK » ② button to confirm the selection.
3. Navigate through the **FAN / DISPLAY / MENU VIEW / FILTER / LINEARIZATION / CCT LIMIT** functions, use the « ▼ » ① and « ▲ » ③ buttons to select the desired function and press « OK » ② to confirm the selection.
4. Within each function select the option to be activated, use the « ▼ » ① and « ▲ » ③ buttons to select one between the options, press « OK » ② to activate it.

Fan: Fan operation. **ON / OFF.**

When the fan is **OFF** the **light intensity** will be adjustable between **0 and 50%**.

Display: Time during which the display backlight stays on. **30sec / 1min / ALWAYS ON.**

Menu View: Type the main MENU, sub-menus and functions to show. **ONLY MANUAL / ONLY DMX / MANUAL/DMX.**

Filter: It is the speed response of the system (smooth factor).

FULL SPEED / NORMAL SPEED / HIGH SPEED / LOW SPEED.

Linearization: Linearization is the compensation curve for the human eye's perception of the luminous intensity emitted as a function of the required power. Required power = dimmer value on the display. **LINEAR / EXPONENTIAL / LOGARITHMIC.**

Linear: No compensation, the intensity of the light is directly proportional to requested power.

Exponential: The light intensity increases from 0 to 100 exponentially.

Logarithmic: The light intensity increases from 0 to 100 logarithmically.

CCT Limit: The colour temperature is limited. **3200K - 5600K / 2800K - 10000K.**

RESET DEVICE

1. Press the « OK » ② button to enter the main MENU.
2. Select **RESET DEVICE** using the « ▼ » ① or « ▲ » ③ buttons, press the « OK » ② button to confirm the selection.
3. Select **YES** with the « ▼ » ① or « ▲ » ③ buttons, press « OK » ② to confirm the selection.
4. The device will ask for further confirmation, select **YES** by pressing the « OK » ② button. **THE DEVICE WILL RETURN TO FACTORY DEFAULT SETTINGS.**

FACTORY DEFAULT SETTING

MANUAL OPERATION

MODE: CCT

DMX OPERATION

MODE: CCT

BIT: 8 BIT

DMX SIGNAL LOSS: Settings 1 MIN

DEVICE SETTINGS

FAN: ON

DISPLAY: 1 min

MENU VIEW : Manual/DMX

FILTER : Normal speed

LINEARIZATION: Linear

CCT LIMIT: 2800K - 10000K.

Package Contents

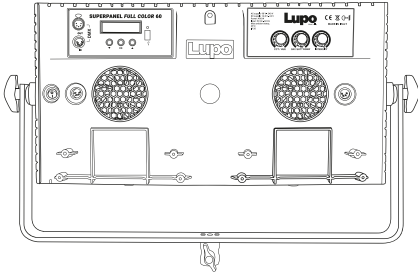

Superpanel Full Color 60

**AC Power Cord +
AC Power Cord Splitter**



**2x AC Adapter
Mounting Bracket**

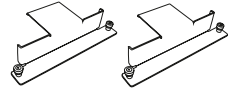

2x AC Adapter

AC input: 100 V - 240 V
DC output: 24 V

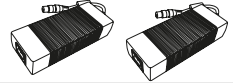

⚠ ATTENTION: Please keep the original package of the product in a safe place for warranty reasons.

Update the Firmware

1. Copy the file on an USB Pendrive (FAT32 formatted) in the main root;
2. Switch off the equipment and insert the USB Pendrive;
3. Switch on the equipment;
4. Wait until display backlight flashes (it takes several minutes and red led must toggle for all time long);
5. Switch off the equipment;
6. Extract the Pendrive and switch on the equipment: the firmware is updated.

MENU e submenus

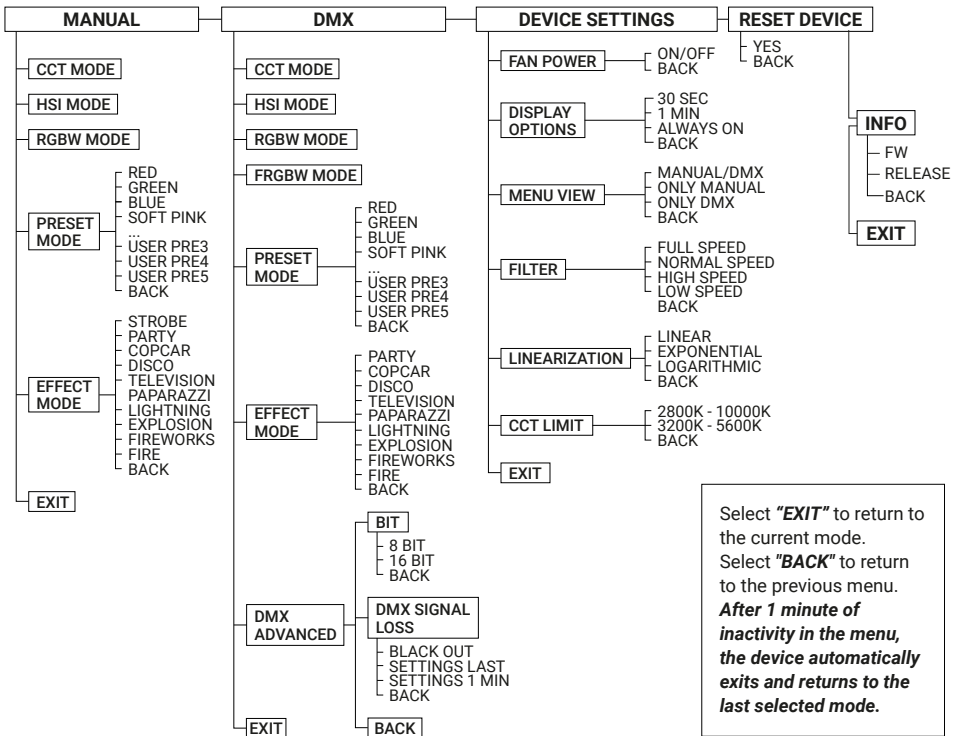

DMX Protocol

Introduction

The Superpanel Full Color 60 can be used with 8 bit or 16 bit DMX control.
(See *DMX OPERATION - advanced settings* in the user's manual).

When used in **8 bit mode** the Superpanel Full Color 60 uses **one channel for each function**. DMX values for each channel are in the range of 0 to 255.

When used in **16 bit mode** the Superpanel Full Color 60 uses **two channels for each function**. The increased resolution offers a smooth dimming and a more accurate color adjustment. DMX values for the first channel (byte 1) are in the range of 256 to 65535 while for the second channel (byte 2) they are in the range of 0 to 255.

The fixture will use the number of channels required based on the light mode selected CCT/HSI/RGBW/PRESET/PARTY/COPCAR/DISCO/TELEVISION/PAPARAZZI/LIGHTNING/EXPLOSION/FIREWORKS/FIRE.

The Superpanel Full Color 60 uses consecutive channels starting from the DMX channel set on the panel (DMX address) used as reference for the connection to the control desk. Please take the above into consideration when using many units of Superpanel Full Color 60 to avoid overlaps.

⚠ ATTENTION: The symbol - ! - on the display indicates that there is **no DMX signal**.

DMX Channel Protocol - 8 bit

MODE	CHANNELS USED	DMX CHANNEL POSITION
CCT	3	1. DIMMER
		2. COLOR TEMPERATURE
		3. GN COMPENSATION
HSI	3	1. DIMMER
		2. HUE
		3. SATURATION
RGBW	7	1. DIMMER
		2. RED
		3. GREEN
		4. BLUE
		5. WHITE
		6. COLOR TEMPERATURE
		7. GN COMPENSATION
FRGBW	7	1. DIMMER
		2. RED
		3. GREEN
		4. BLUE
		5. WHITE
		6. COLOR TEMPERATURE
		7. GN COMPENSATION
PRESET	1	1. DIMMER
PARTY	2	1. DIMMER
		2. SPEED
COPCAR	3	1. DIMMER
		2. NUMBER OF COLORS
		3. NUMBER OF FLASH
DISCO	2	1. DIMMER
		2. SPEED
TELEVISION	3	1. DIMMER
		2. WHITE RANGE
		3. FREQUENCY
PAPARAZZI	3	1. DIMMER
		2. INTERVAL
		3. BULB TYPE
LIGHTNING	3	1. DIMMER
		2. COLOR TEMPERATURE
		3. INTERVAL

EXPLOSION	2	1. DIMMER
		2. SPEED
FIREWORKS	2	1. DIMMER
		2. SPEED
FIRE	2	1. DIMMER
		2. SPEED

DMX Channel Protocol - 16 bit

MODE	CHANNELS USED	DMX CHANNEL POSITION
CCT	6	1. DIMMER - byte 1
		2. DIMMER - byte 2
		3. COLOR TEMPERATURE - byte 1
		4. COLOR TEMPERATURE - byte 2
		5. GN COMPENSATION - byte 1
		6. GN COMPENSATION - byte 2
HSI	6	1. DIMMER - byte 1
		2. DIMMER - byte 2
		3. HUE - byte 1
		4. HUE - byte 2
		5. SATURATION - byte 1
		6. SATURATION - byte 2
RGBW	14	1. DIMMER - byte 1
		2. DIMMER - byte 2
		3. RED - byte 1
		4. RED - byte 2
		5. GREEN - byte 1
		6. GREEN - byte 2
		7. BLUE - byte 1
		8. BLUE - byte 2
		9. WHITE - byte 1
		10. WHITE - byte 2
		11. COLOR TEMPERATURE - byte 1
		12. COLOR TEMPERATURE - byte 2
		13. GN COMPENSATION - byte 1
		14. GN COMPENSATION - byte 2
FRGBW	14	1. DIMMER - byte 1
		2. DIMMER - byte 2
		3. RED - byte 1
		4. RED - byte 2
		5. GREEN - byte 1
		6. GREEN - byte 2
		7. BLUE - byte 1
		8. BLUE - byte 2
		9. WHITE - byte 1
		10. WHITE - byte 2
		11. COLOR TEMPERATURE - byte 1
		12. COLOR TEMPERATURE - byte 2
		13. GN COMPENSATION - byte 1
		14. GN COMPENSATION - byte 2
PRESET	2	1. DIMMER - byte 1
		2. DIMMER - byte 2
PARTY	4	1. DIMMER - byte 1
		2. DIMMER - byte 2
		3. SPEED - byte 1
		4. SPEED - byte 2
COPCAR	6	1. DIMMER - byte 1
		2. DIMMER - byte 2
		3. NUMBER OF COLORS - byte 1
		4. NUMBER OF COLORS - byte 2
		5. NUMBER OF FLASH - byte 1
		6. NUMBER OF FLASH - byte 2

DISCO	4	1. DIMMER - byte 1
		2. DIMMER - byte 2
		3. SPEED - byte 1
		4. SPEED - byte 2
TELEVISION	6	1. DIMMER - byte 1
		2. DIMMER - byte 2
		3. WHITE RANGE - byte 1
		4. WHITE RANGE - byte 2
		5. FREQUENCY - byte 1
		6. FREQUENCY - byte 2
PAPARAZZI	6	1. DIMMER - byte 1
		2. DIMMER - byte 2
		3. INTERVAL - byte 1
		4. INTERVAL - byte 2
		5. BULB TYPE - byte 1
		6. BULB TYPE - byte 2
LIGHTNING	6	1. DIMMER - byte 1
		2. DIMMER - byte 2
		3. COLOR TEMPERATURE - byte 1
		4. COLOR TEMPERATURE - byte 2
		5. INTERVAL - byte 1
		6. INTERVAL - byte 2
EXPLOSION	4	1. DIMMER - byte 1
		2. DIMMER - byte 2
		3. SPEED - byte 1
		4. SPEED - byte 2
FIREWORKS	4	1. DIMMER - byte 1
		2. DIMMER - byte 2
		3. SPEED - byte 1
		4. SPEED - byte 2
FIRE	4	1. DIMMER - byte 1
		2. DIMMER - byte 2
		3. SPEED - byte 1
		4. SPEED - byte 2

RDM Protocol Specification

COMMAND	PID	DESCRIPTION
Manufacturer ID	0x0622	Manufacturer identification number (LUPO Lighting).
Device Identification		
Model ID		Model identification number
	0x0000	Dayled 650 mono color
	0x0001	Dayled 650 dual color
	0x0002	Dayled 1000 mono color
	0x0003	Dayled 1000 dual color
	0x0004	Dayled 2000 mono color
	0x0005	Dayled 2000 dual color
	0x0006	Superpanel 30 dual color soft
	0x0007	Superpanel 30 dual color lens
	0x0008	Superpanel 30 fullcolor soft
	0x0009	Superpanel 30 fullcolor lens
	0x0010	Superpanel 60 dual color soft
	0x0011	Superpanel 60 dual color lens

Model ID		Model identification number
	0x0012	Superpanel 60 fullcolor soft
	0x0013	Superpanel 60 fullcolor lens
	0x0014	Actionpanel dual color soft
	0x0015	Actionpanel dual color lens
	0x0016	Actionpanel fullcolor soft
	0x0017	Actionpanel fullcolor lens
	0x0018	Kickasspanel dual color
	0x0019	Kickasspanel fullcolor
	0x0020	Lupoled monocolour
	0x0021	Lupoled dualcolor
Personality		DMX Personality
	0x00	CCT
	0x01	HSI
	0x02	RGBW
	0x03	FRGBW
	0x04	PRESET
	0x05	PARTY
	0x06	COPCAR
	0x07	DISCO 1
	0x08	DISCO 2
	0x09	TELEVISION BW
	0x0A	TELEVISION CO
	0x0B	PAPARAZZI
	0x0C	LIGHTNING
	0x0D	EXPLOSION
	0x0E	FIREWORKS
	0x0F	FIRE
Network management		
DISC UNIQUE BRANCH	0x0001	Search RDM devices
DISC MUTE	0x0002	Mute RDM device, no response message
DISC UN MUTE	0x0003	Activate RDM device fo response message
Status collection		
QUEUED MESSAGES	0x0020	Retrieves queued messages or status message if no message is in queue
STATUS MESSAGES	0x0030	Retrieves current Warning/Error messages
RDM Information		
SUPPORTED PARAMETERS	0x0050	Retrieves a list of all supported RDM commands
PARAMETER DESCRIPTION	0x0051	Retrieves a list of all RDM commands
Product Information		
DEVICE INFO	0x0060	Retrieves a variety of information about the device that is normally required by a controller.
DEVICE MODEL DESCRIPTION	0x0080	Text description of up to 32 characters for the device model type.

MANUFACTURER LABEL	0x0081	This parameter provides an ASCII text response with the Manufacturer name for the device. "LUPO" is the default name.
FACTORY DEFAULTS	0x0090	Set the device to its factory defaults. Get: Check if settings still in default state -> 1 if default
SOFTWARE VERSION LABEL	0x00C0	Retrieves software version string of main software
DMX512 Setup		
DMX PERSONALITY	0x00E0	DMX mode
DMX PERSONALITY DESCRIPTION	0x00E1	Shows a description of a DMX-Mode, max 32 characters
DMX START ADDRESS	0x00F0	DMX address
Control		
IDENTIFY DEVICE	0x1000	The identify flag (flashes the light)
Manufacturer Commands		
FAN MODE	0x8001	0: Off 1: On
DISPLAY TIMEOUT	0x8002	0: 30 sec 1: 1 min 2: always on
DMX SIGNAL LOST MODE	0x8003	0: black out 1: last settings on 2: last settings 1 min
DMX BITS	0x8004	0: 8 bit 1: 16 bit
CCT LIMIT	0x8005	0: 2800-10000 1: 3200-5600
LINEARIZATION	0x8006	0: linear 1: exponential 2: logarithmic
FILTER	0x8007	0: full speed 1: normal speed 2: high speed 3: low speed

RDM

Protocol Specification

COMMAND	PID	DESCRIPTION
Manufacturer ID	0x0622	Manufacturer identification number (LUPO Lighting).
Device Identification		
Model ID		Model identification number
	0x0000	Dayled 650 mono color
	0x0001	Dayled 650 dual color
	0x0002	Dayled 1000 mono color
	0x0003	Dayled 1000 dual color
	0x0004	Dayled 2000 mono color
	0x0005	Dayled 2000 dual color
	0x0006	Superpanel 30 dual color soft
	0x0007	Superpanel 30 dual color lens
	0x0008	Superpanel 30 fullcolor soft
	0x0009	Superpanel 30 fullcolor lens
	0x0010	Superpanel 60 dual color soft
	0x0011	Superpanel 60 dual color lens

	0x0012	Superpanel 60 fullcolor soft
	0x0013	Superpanel 60 fullcolor lens
	0x0014	Actionpanel dual color soft
	0x0015	Actionpanel dual color lens
	0x0016	Actionpanel fullcolor soft
	0x0017	Actionpanel fullcolor lens
	0x0018	Kickasspanel dual color
	0x0019	Kickasspanel fullcolor
	0x0020	Lupoled monocolor
	0x0021	Lupoled dualcolor
Personality		DMX Personality
	0x00	CCT
	0x01	HSI
	0x02	RGBW
	0x03	FRGBW
	0x04	PRESET
	0x05	PARTY
	0x06	COPCAR
	0x07	DISCO 1
	0x08	DISCO 2
	0x09	TELEVISION BW
	0x0A	TELEVISION CO
	0x0B	PAPARAZZI
	0x0C	LIGHTNING
	0x0D	EXPLOSION
	0x0E	FIREWORKS
	0x0F	FIRE
Network management		
DISC UNIQUE BRANCH	0x0001	Search RDM devices
DISC MUTE	0x0002	Mute RDM device, no response message
DISC UN MUTE	0x0003	Activate RDM device fo response message
Status collection		
QUEUED MESSAGES	0x0020	Retrieves queued messages or status message if no message is in queue
STATUS MESSAGES	0x0030	Retrieves current Warning/Error messages
RDM Information		
SUPPORTED PARAMETERS	0x0050	Retrieves a list of all supported RDM commands
PARAMETER DESCRIPTION	0x0051	Retrieves a list of all RDM commands
Product Information		
DEVICE INFO	0x0060	Retrieves a variety of information about the device that is normally required by a controller.
DEVICE MODEL DESCRIPTION	0x0080	Text description of up to 32 characters for the device model type.
MANUFACTURER LABEL	0x0081	This parameter provides an ASCII text response with the Manufacturer name for the device. "LUPO" is the default name.
FACTORY DEFAULTS	0x0090	Set the device to its factory defaults. Get: Check if settings still in default state -> 1 if default

SOFTWARE VERSION LABEL	0x00C0	Retrieves software version string of main software
DMX512 Setup		
DMX PERSONALITY	0x00E0	DMX mode
DMX PERSONALITY DESCRIPTION	0x00E1	Shows a description of a DMX-Mode, max 32 characters
DMX START ADDRESS	0x00F0	DMX address
Control		
IDENTIFY DEVICE	0x1000	The identify flag (flashes the light)
Manufacturer Commands		
FAN MODE	0x8001	0: Off 1: On
DISPLAY TIMEOUT	0x8002	0: 30 sec 1: 1 min 2: always on
DMX SIGNAL LOST MODE	0x8003	0: black out 1: last settings on 2: last settings 1 min
DMX BITS	0x8004	0: 8 bit 1: 16 bit
CCT LIMIT	0x8005	0: 2800-10000 1: 3200-5600
LINEARIZATION	0x8006	0: linear 1: exponential 2: logarithmic
FILTER	0x8007	0: full speed 1: normal speed 2: high speed 3: low speed